









Parts List & Hardware List

	PARTS LIST		Qty
A		HEADBOARD	1 PC
B		FOOTBOARD	1 PC
C		SIDE RAIL	2 PCS
D		SLAT	3 PCS
E		CENTER SUPPORT LEG 3 PCS FOR QUEEN BED 6 PCS FOR KING/CAL KING BED	

HARDWARE LIST			QTY
1	BOLT	 5/16" x 2"	16 PCS
2	LOCK WASHER	 5/16"	16 PCS
3	WRENCH	 87" 12mm	1 PC
4	WOOD SCREW	 8" 1-1/4"	6 PCS



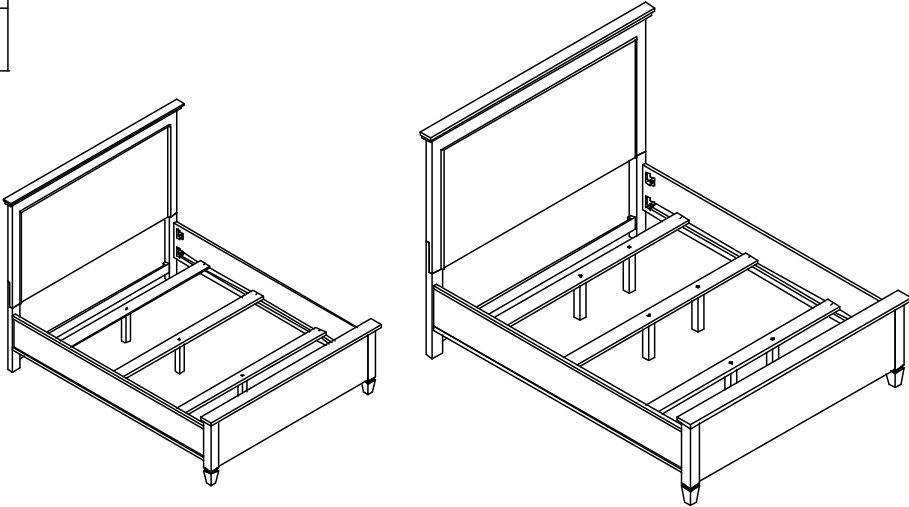
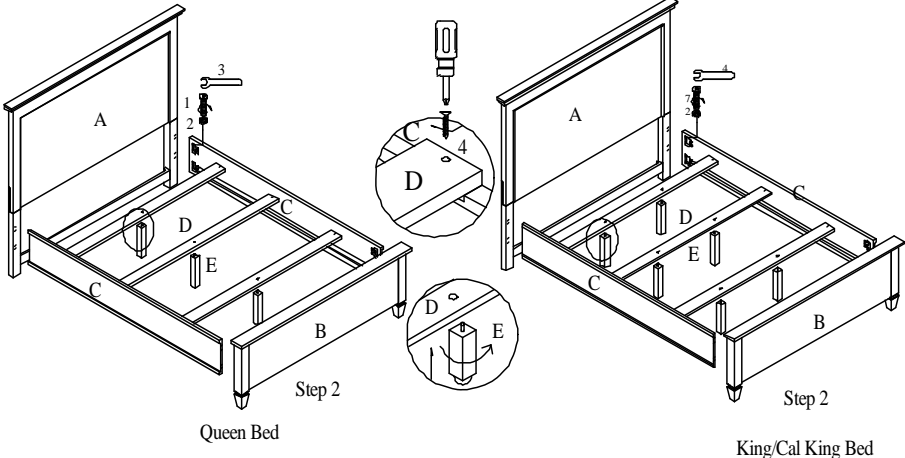









Assembly Procedures:

- Step 1: Lay out all parts and hardware. Make sure the quantity of each is correct.
- Step 2: Assemble the side rails (C) to headboard (A) and footboard (B).
- Step 3: Assemble the support leg (E) (Queen Bed has three support legs and king /Cal King Bed has 6 support legs) to slats (D). Then assemble the slats to bed rails (C).

Assembly is now complete.

Parts List & Hardware List

HARDWARE LIST			QTY
1	BOLT	 5/16"x2"	16 PCS
2	LOCK WASHER	 5/16"	16 PCS
3	WRENCH	 87*12mm	1 PC
4	WOOD SCREW	 8*1-1/4"	12 PCS
5	WOOD SCREW	 8*1"	20 PCS

PARTS LIST		Qty	PARTS LIST		Qty
A	 FOOTBOARD	1 PC	D	 SLAT	6 PCS
B	 HEADBOARD	1 PC	E	 SUPPORT LEG	4 PCS FOR QUEEN BED 8 PCS FOR KING/CAL KING BED
C	 SIDE RAIL	2 PCS	F	 MATTRESS SUPPORT PANEL	5 PCS

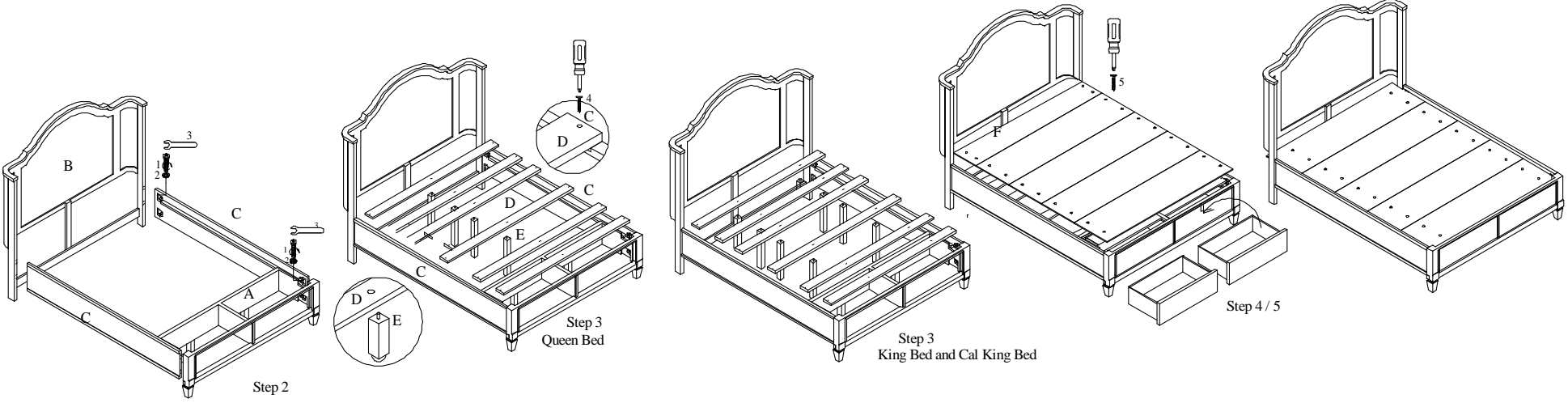











Assembly Procedures:

- Step 1: Lay out all parts and hardware. Make sure the quantity of each is correct.
- Step 2: Assemble the bed rails (C) to headboard (B) and footboard (A).
- Step 3: Assemble the support leg (E) (Queen Bed has four support legs and king /Cal King Bed has 8 support legs) to slats (D). Then assemble the slats to bed rails (C).
- Step 4: Place narrowest mattress support panel (F) closest to the headboard, then put others on bed slats one by one and screw it with hardware provided.
- Step 5: Install the drawers.

Assembly is now complete.

Parts List & Hardware List

HARDWARE LIST			QTY
1	SHORT BOLT	 5/16" * 1-3/8"	6 PCS
2	LOCK WASHER	 5/16"	8 PCS
3	FLAT WASHER	 5/16"	8 PCS
4	WRENCH	 87*12mm	1 PC
5	LONG BOLT	 5/16" * 1-3/4"	2 PCS
6	DOWEL	 10*40MM	4 PCS

PARTS LIST			Qty
A		HEADBOARD	1 PC
B		LEFT POST	1 PC
C		RIGHT POST	1 PC
D		STRETCHER	1 PC

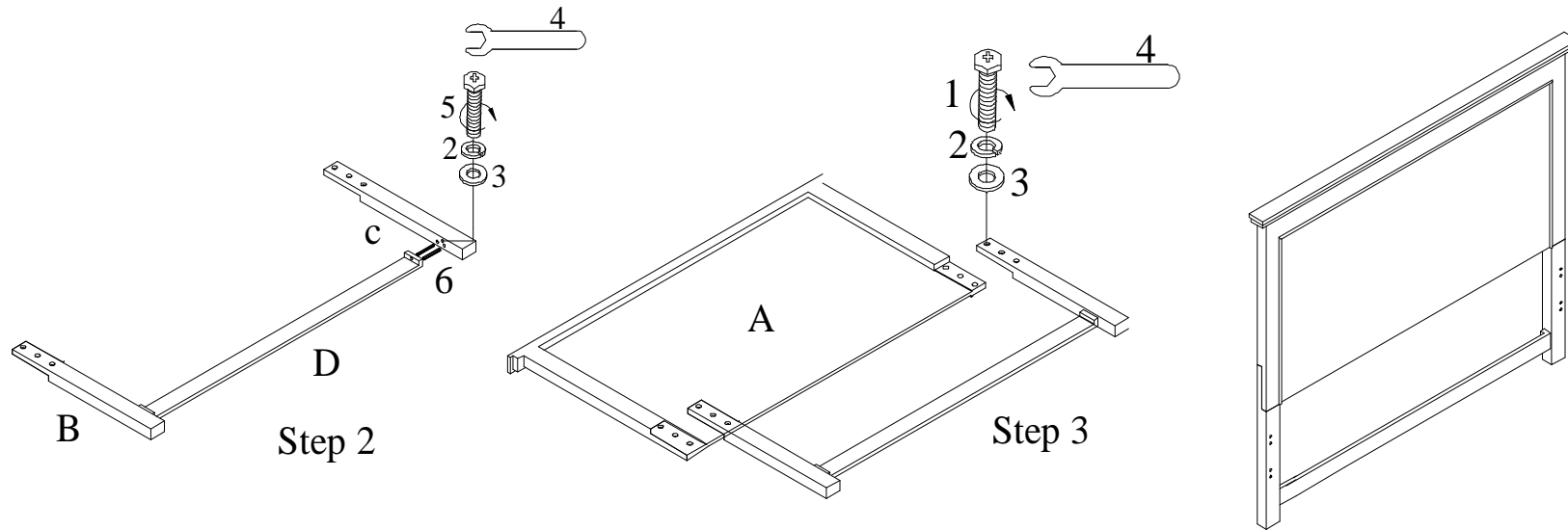

Assembly Procedures:

Step 1: Lay out all parts and hardware. Make sure the quantity of each is correct.

Step 2: Assemble the left & right posts (B&C) to stretcher (D).



Step 3: Assemble the headboard to left & right posts.



Assembly is now complete.

Assembly Instruction

2760 Storage Footboard

Parts & Hardware List

PARTS LIST			Qty
A		FOOTBOARD	1 PC
B		LEG	2 PCS
C		CENTER SUPPORT LEG	2 PCS

HARDWARE LIST			QTY
1	BOLT	 5/16"*2"	4 PCS
2	LOCK WASHER	 5/16"	4 PCS
3	FLAT WASHER	 5/16"	4 PCS
4	WRENCH	 87*12mm	1 PC

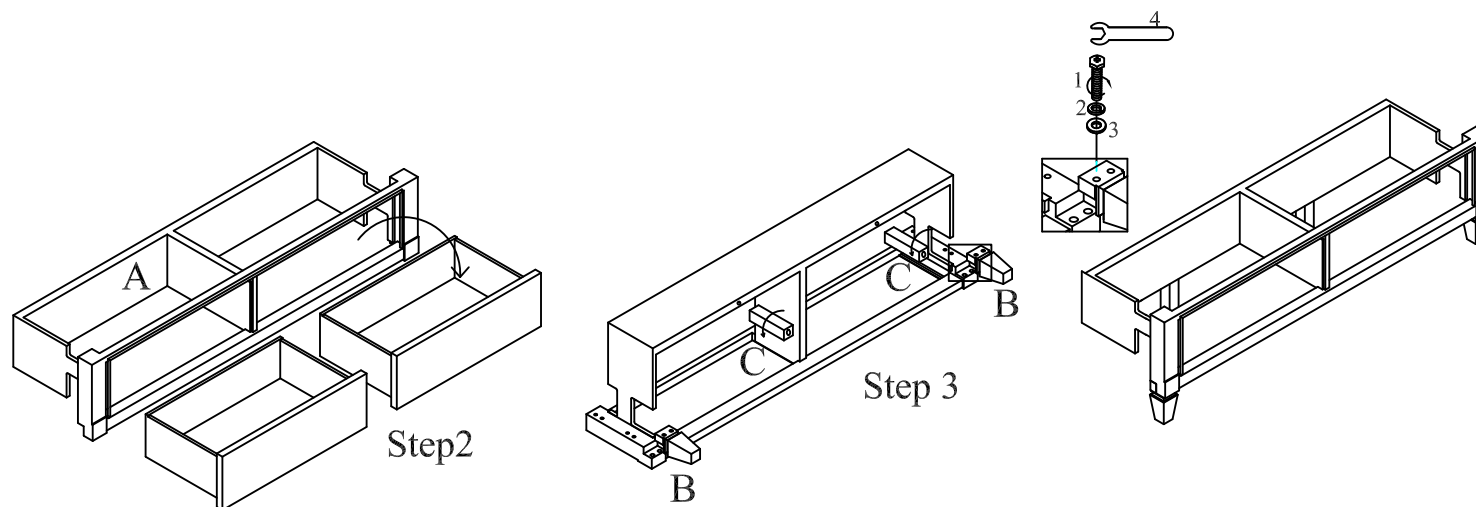

Assembly Procedures:

Step 1: Lay out all parts and hardware. Make sure the quantity of each is correct.

Step 2: Remove the drawers from the footboard.

Step 3: Assemble the leg (B) and support leg (C) to footboard (A).

Assembly is now complete.